

NGD18N40CLB

Ignition IGBT 18 Amps, 400 Volts

N-Channel DPAK

This Logic Level Insulated Gate Bipolar Transistor (IGBT) features monolithic circuitry integrating ESD and Over-Voltage clamped protection for use in inductive coil drivers applications. Primary uses include Ignition, Direct Fuel Injection, or wherever high voltage and high current switching is required.

Features

- Ideal for Coil-on-Plug Applications
- DPAK Package Offers Smaller Footprint for Increased Board Space
- Gate-Emitter ESD Protection
- Temperature Compensated Gate-Collector Voltage Clamp Limits Stress Applied to Load
- Integrated ESD Diode Protection
- New Design Increases Unclamped Inductive Switching (UIS) Energy Per Area
- Low Threshold Voltage Interfaces Power Loads to Logic or Microprocessor Devices
- Low Saturation Voltage
- High Pulsed Current Capability
- Optional Gate Resistor (R_G) and Gate-Emitter Resistor (R_{GE})
- Emitter Ballasting for Short-Circuit Capability
- Pb-Free Package is Available*

MAXIMUM RATINGS ($T_J = 25^\circ\text{C}$ unless otherwise noted)

Rating	Symbol	Value	Unit
Collector-Emitter Voltage	V_{CES}	430	V_{DC}
Collector-Gate Voltage	V_{CER}	430	V_{DC}
Gate-Emitter Voltage	V_{GE}	18	V_{DC}
Collector Current-Continuous @ $T_C = 25^\circ\text{C}$ - Pulsed	I_C	15 50	A_{DC} A_{AC}
ESD (Human Body Model) $R = 1500 \Omega$, $C = 100 \text{ pF}$	ESD	8.0	kV
ESD (Machine Model) $R = 0 \Omega$, $C = 200 \text{ pF}$	ESD	800	V
Total Power Dissipation @ $T_C = 25^\circ\text{C}$ Derate above 25°C	P_D	115 0.77	Watts $W/^\circ\text{C}$
Operating and Storage Temperature Range	T_J, T_{stg}	-55 to +175	$^\circ\text{C}$

Stresses exceeding Maximum Ratings may damage the device. Maximum Ratings are stress ratings only. Functional operation above the Recommended Operating Conditions is not implied. Extended exposure to stresses above the Recommended Operating Conditions may affect device reliability.

*For additional information on our Pb-Free strategy and soldering details, please download the ON Semiconductor Soldering and Mounting Techniques Reference Manual, SOLDERRM/D.



ON Semiconductor®

<http://onsemi.com>

**18 AMPS
400 VOLTS**

$V_{CE(on)} \leq 2.0 \text{ V @}$
 $I_C = 10 \text{ A}, V_{GE} \geq 4.5 \text{ V}$

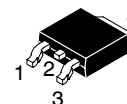
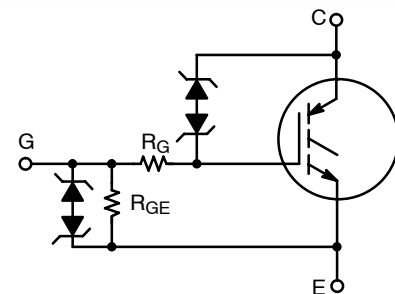

**DPAK
CASE 369C
STYLE 7**

MARKING DIAGRAM

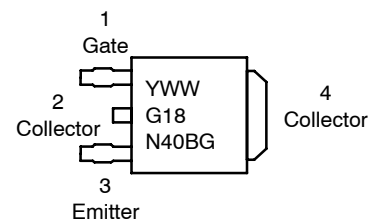

G18N40B = Device Code
Y = Year
WW = Work Week
G = Pb-Free Device

ORDERING INFORMATION

Device	Package	Shipping†
NGD18N40CLBT4	DPAK	2500/Tape & Reel
NGD18N40CLBT4G	DPAK (Pb-Free)	2500/Tape & Reel

†For information on tape and reel specifications, including part orientation and tape sizes, please refer to our Tape and Reel Packaging Specification Brochure, BRD8011/D.

NGD18N40CLB

UNCLAMPED COLLECTOR-TO-EMITTER AVALANCHE CHARACTERISTICS ($-55^{\circ} \leq T_J \leq 175^{\circ} \text{C}$)

Characteristic	Symbol	Value	Unit
Single Pulse Collector-to-Emitter Avalanche Energy $V_{CC} = 50 \text{ V}$, $V_{GE} = 5.0 \text{ V}$, Pk $I_L = 21.1 \text{ A}$, $L = 1.8 \text{ mH}$, Starting $T_J = 25^{\circ} \text{C}$ $V_{CC} = 50 \text{ V}$, $V_{GE} = 5.0 \text{ V}$, Pk $I_L = 16.2 \text{ A}$, $L = 3.0 \text{ mH}$, Starting $T_J = 25^{\circ} \text{C}$ $V_{CC} = 50 \text{ V}$, $V_{GE} = 5.0 \text{ V}$, Pk $I_L = 18.3 \text{ A}$, $L = 1.8 \text{ mH}$, Starting $T_J = 125^{\circ} \text{C}$	E_{AS}	400 400 300	mJ
Reverse Avalanche Energy $V_{CC} = 100 \text{ V}$, $V_{GE} = 20 \text{ V}$, Pk $I_L = 25.8 \text{ A}$, $L = 6.0 \text{ mH}$, Starting $T_J = 25^{\circ} \text{C}$	$E_{AS(R)}$	2000	mJ

MAXIMUM SHORT-CIRCUIT TIMES ($-55^{\circ} \text{C} \leq T_J \leq 150^{\circ} \text{C}$)

Short Circuit Withstand Time 1 (See Figure 17, 3 Pulses with 10 ms Period)	t_{sc1}	750	μs
Short Circuit Withstand Time 2 (See Figure 18, 3 Pulses with 10 ms Period)	t_{sc2}	5.0	ms

THERMAL CHARACTERISTICS

Thermal Resistance, Junction to Case	$R_{\theta JC}$	1.3	$^{\circ}\text{C}/\text{W}$
Thermal Resistance, Junction to Ambient DPAK (Note 1)	$R_{\theta JA}$	95	$^{\circ}\text{C}/\text{W}$
Maximum Lead Temperature for Soldering Purposes, 1/8" from case for 5 seconds	T_L	275	$^{\circ}\text{C}$

ELECTRICAL CHARACTERISTICS

Characteristic	Symbol	Test Conditions	Temperature	Min	Typ	Max	Unit
----------------	--------	-----------------	-------------	-----	-----	-----	------

OFF CHARACTERISTICS

Collector-Emitter Clamp Voltage	BV_{CES}	$I_C = 2.0 \text{ mA}$	$T_J = -40^{\circ}\text{C}$ to 150°C	380	395	420	V_{DC}
		$I_C = 10 \text{ mA}$	$T_J = -40^{\circ}\text{C}$ to 150°C	390	405	430	
Zero Gate Voltage Collector Current	I_{CES}	$V_{CE} = 350 \text{ V}$, $V_{GE} = 0 \text{ V}$	$T_J = 25^{\circ}\text{C}$	-	2.0	20	μA_{DC}
			$T_J = 150^{\circ}\text{C}$	-	10	40*	
			$T_J = -40^{\circ}\text{C}$	-	1.0	10	
Reverse Collector-Emitter Leakage Current	I_{ECS}	$V_{CE} = -24 \text{ V}$	$T_J = 25^{\circ}\text{C}$	-	0.7	1.0	mA
			$T_J = 150^{\circ}\text{C}$	-	12	25*	
			$T_J = -40^{\circ}\text{C}$	-	0.1	1.0	
Reverse Collector-Emitter Clamp Voltage	$BV_{CES(R)}$	$I_C = -75 \text{ mA}$	$T_J = 25^{\circ}\text{C}$	27	33	37	V_{DC}
			$T_J = 150^{\circ}\text{C}$	30	36	40	
			$T_J = -40^{\circ}\text{C}$	25	32	35	
Gate-Emitter Clamp Voltage	BV_{GES}	$I_G = 5.0 \text{ mA}$	$T_J = -40^{\circ}\text{C}$ to 150°C	11	13	15	V_{DC}
Gate-Emitter Leakage Current	I_{GES}	$V_{GE} = 10 \text{ V}$	$T_J = -40^{\circ}\text{C}$ to 150°C	384	640	700	μA_{DC}
Gate Resistor	R_G	-	$T_J = -40^{\circ}\text{C}$ to 150°C	-	70	-	Ω
Gate Emitter Resistor	R_{GE}	-	$T_J = -40^{\circ}\text{C}$ to 150°C	10	16	26	k Ω

1. When surface mounted to an FR4 board using the minimum recommended pad size.

*Maximum Value of Characteristic across Temperature Range.

NGD18N40CLB

ELECTRICAL CHARACTERISTICS (continued)

Characteristic	Symbol	Test Conditions	Temperature	Min	Typ	Max	Unit
ON CHARACTERISTICS (Note 2)							
Gate Threshold Voltage	$V_{GE(th)}$	$I_C = 1.0 \text{ mA}$, $V_{GE} = V_{CE}$	$T_J = 25^\circ\text{C}$	1.1	1.4	1.9	V_{DC}
			$T_J = 150^\circ\text{C}$	0.75	1.0	1.4	
			$T_J = -40^\circ\text{C}$	1.2	1.6	2.1*	
Threshold Temperature Coefficient (Negative)	-	-	-	-	3.4	-	$\text{mV}/^\circ\text{C}$
Collector-to-Emitter On-Voltage	$V_{CE(on)}$	$I_C = 6.0 \text{ A}$, $V_{GE} = 4.0 \text{ V}$	$T_J = 25^\circ\text{C}$	1.0	1.4	1.6	V_{DC}
			$T_J = 150^\circ\text{C}$	0.9	1.3	1.6	
			$T_J = -40^\circ\text{C}$	1.1	1.45	1.7*	
		$I_C = 8.0 \text{ A}$, $V_{GE} = 4.0 \text{ V}$	$T_J = 25^\circ\text{C}$	1.3	1.6	1.9*	
			$T_J = 150^\circ\text{C}$	1.2	1.55	1.8	
			$T_J = -40^\circ\text{C}$	1.4	1.6	1.9*	
		$I_C = 10 \text{ A}$, $V_{GE} = 4.0 \text{ V}$	$T_J = 25^\circ\text{C}$	1.4	1.8	2.05	
			$T_J = 150^\circ\text{C}$	1.4	1.8	2.0	
			$T_J = -40^\circ\text{C}$	1.4	1.8	2.1*	
		$I_C = 15 \text{ A}$, $V_{GE} = 4.0 \text{ V}$	$T_J = 25^\circ\text{C}$	1.8	2.2	2.5	
			$T_J = 150^\circ\text{C}$	2.0	2.4	2.6*	
			$T_J = -40^\circ\text{C}$	1.7	2.1	2.5	
		$I_C = 10 \text{ A}$, $V_{GE} = 4.5 \text{ V}$	$T_J = 25^\circ\text{C}$	1.3	1.8	2.0*	
			$T_J = 150^\circ\text{C}$	1.3	1.75	2.0*	
			$T_J = -40^\circ\text{C}$	1.4	1.8	2.0*	
$I_C = 6.5 \text{ A}$, $V_{GE} = 3.7 \text{ V}$	$T_J = 25^\circ\text{C}$	-	-	1.65			
Forward Transconductance	g_{fs}	$V_{CE} = 5.0 \text{ V}$, $I_C = 6.0 \text{ A}$	$T_J = -40^\circ\text{C}$ to 150°C	8.0	14	25	Mhos

DYNAMIC CHARACTERISTICS

Input Capacitance	C_{ISS}	$V_{CC} = 25 \text{ V}$, $V_{GE} = 0 \text{ V}$ $f = 1.0 \text{ MHz}$	$T_J = -40^\circ\text{C}$ to 150°C	400	800	1000	pF
Output Capacitance	C_{OSS}			50	75	100	
Transfer Capacitance	C_{RSS}			4.0	7.0	10	

SWITCHING CHARACTERISTICS

Turn-Off Delay Time (Resistive)	$t_{d(off)}$	$V_{CC} = 300 \text{ V}$, $I_C = 6.5 \text{ A}$ $R_G = 1.0 \text{ k}\Omega$, $R_L = 46 \Omega$	$T_J = 25^\circ\text{C}$	-	4.0	10	μSec
Fall Time (Resistive)	t_f	$V_{CC} = 300 \text{ V}$, $I_C = 6.5 \text{ A}$ $R_G = 1.0 \text{ k}\Omega$, $R_L = 46 \Omega$	$T_J = 25^\circ\text{C}$	-	9.0	15	
Turn-On Delay Time	$t_{d(on)}$	$V_{CC} = 10 \text{ V}$, $I_C = 6.5 \text{ A}$ $R_G = 1.0 \text{ k}\Omega$, $R_L = 1.5 \Omega$	$T_J = 25^\circ\text{C}$	-	0.7	4.0	μSec
Rise Time	t_r	$V_{CC} = 10 \text{ V}$, $I_C = 6.5 \text{ A}$ $R_G = 1.0 \text{ k}\Omega$, $R_L = 1.5 \Omega$	$T_J = 25^\circ\text{C}$	-	4.5	7.0	

2. Pulse Test: Pulse Width $\leq 300 \mu\text{s}$, Duty Cycle $\leq 2\%$.

*Maximum Value of Characteristic across Temperature Range.

NGD18N40CLB

TYPICAL ELECTRICAL CHARACTERISTICS (unless otherwise noted)

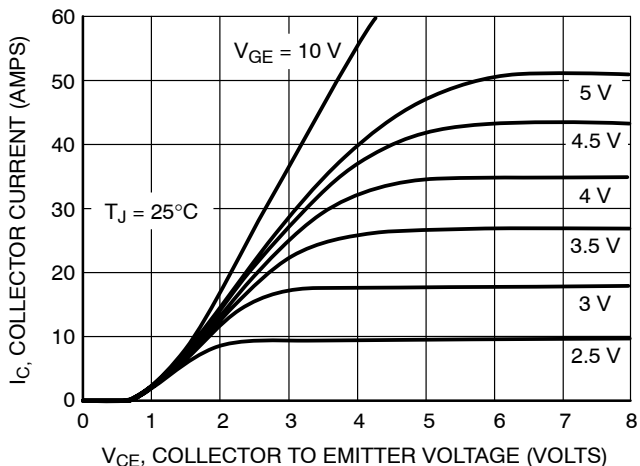

Figure 1. Output Characteristics

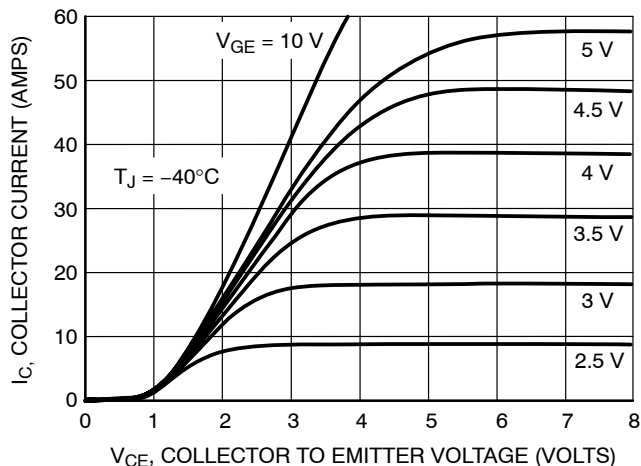

Figure 2. Output Characteristics

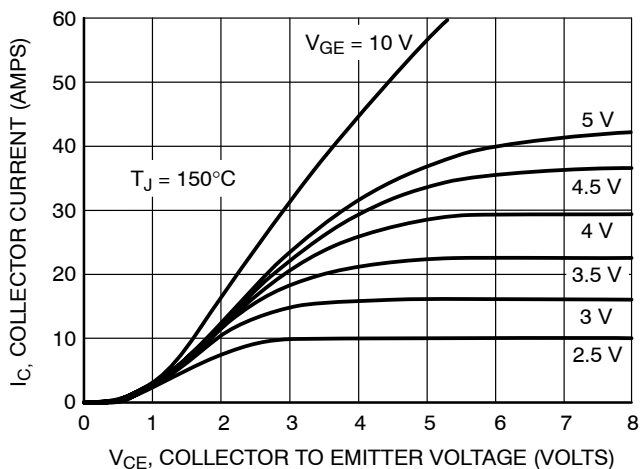

Figure 3. Output Characteristics

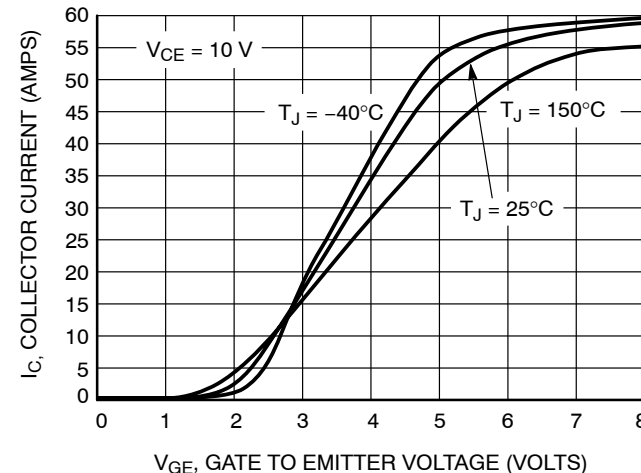

Figure 4. Transfer Characteristics

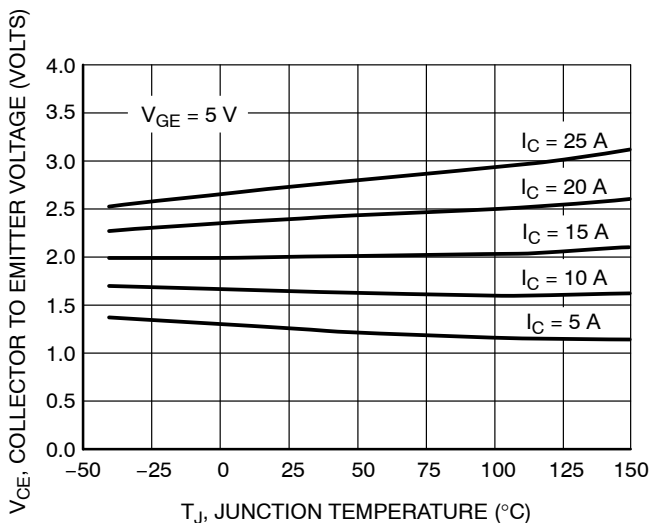

Figure 5. Collector-to-Emitter Saturation Voltage versus Junction Temperature

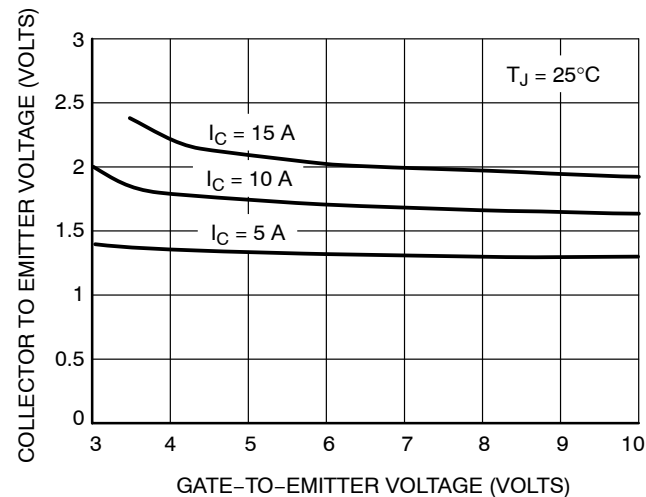

Figure 6. Collector-to-Emitter Voltage versus Gate-to-Emitter Voltage

NGD18N40CLB

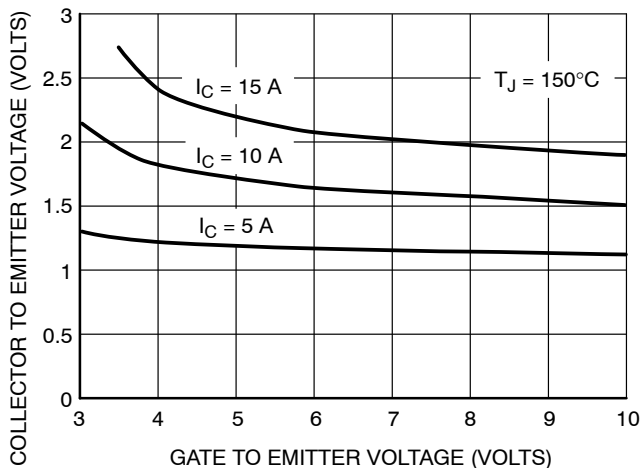

Figure 7. Collector-to-Emitter Voltage versus Gate-to-Emitter Voltage

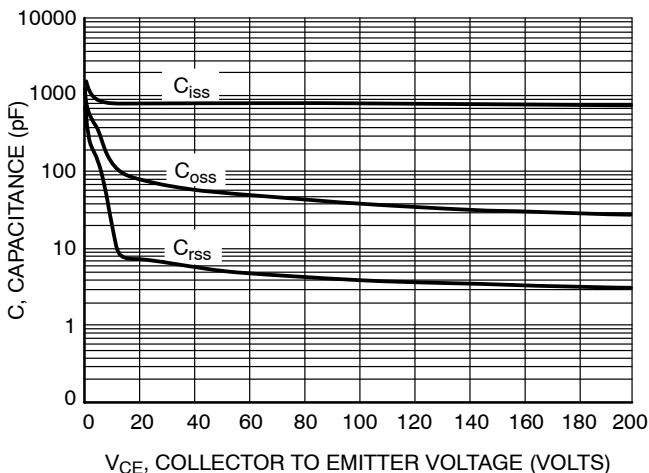

Figure 8. Capacitance Variation

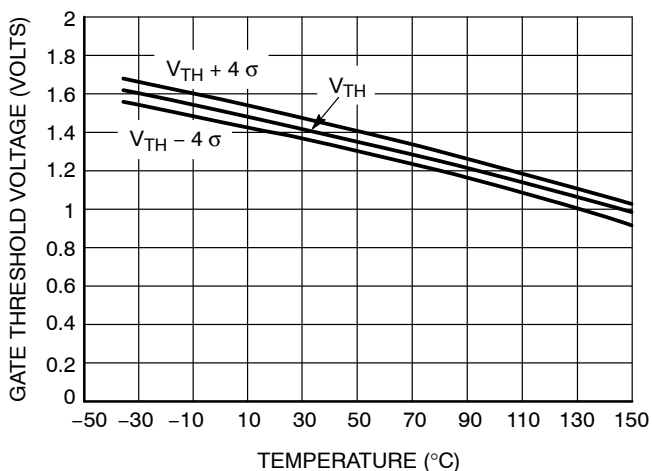

Figure 9. Gate Threshold Voltage versus Temperature

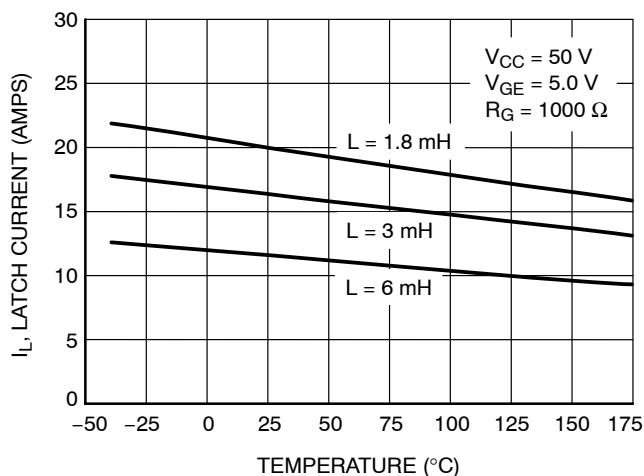

Figure 10. Minimum Open Secondary Latch Current versus Temperature

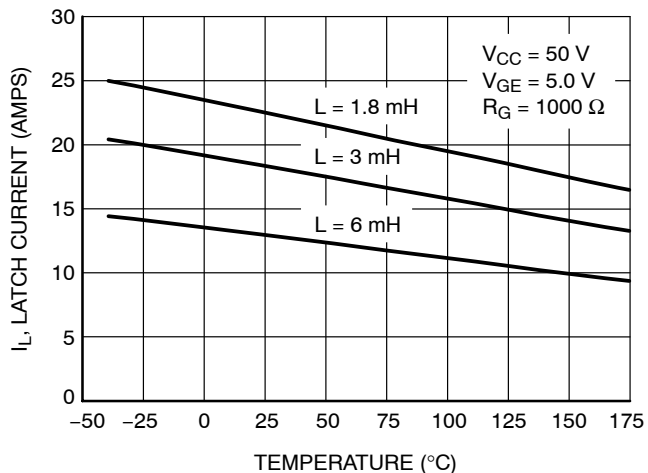

Figure 11. Typical Open Secondary Latch Current versus Temperature

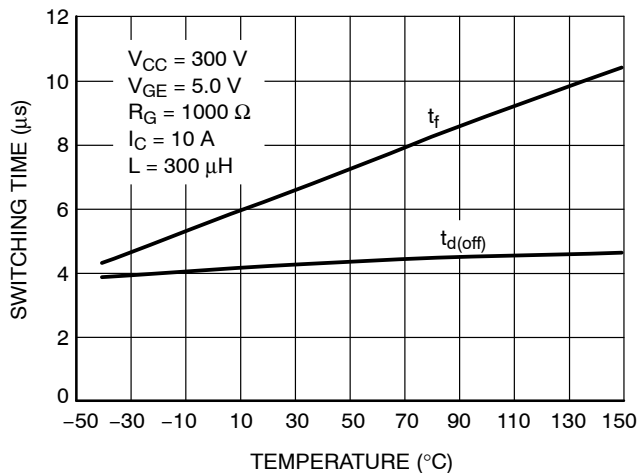

Figure 12. Inductive Switching Fall Time versus Temperature

NGD18N40CLB

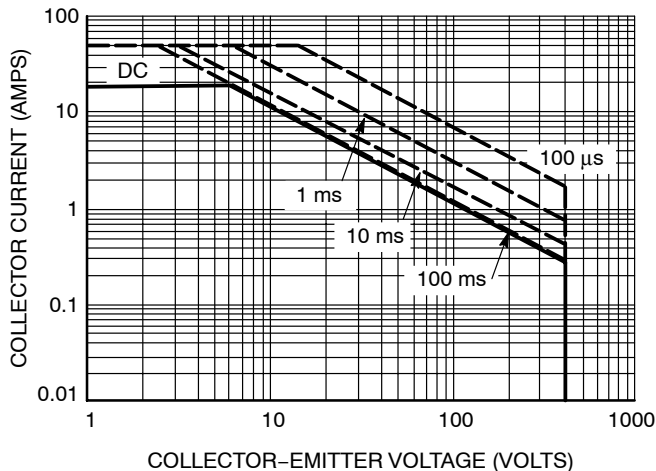

Figure 13. Single Pulse Safe Operating Area (Mounted on an Infinite Heatsink at $T_A = 25^\circ\text{C}$)

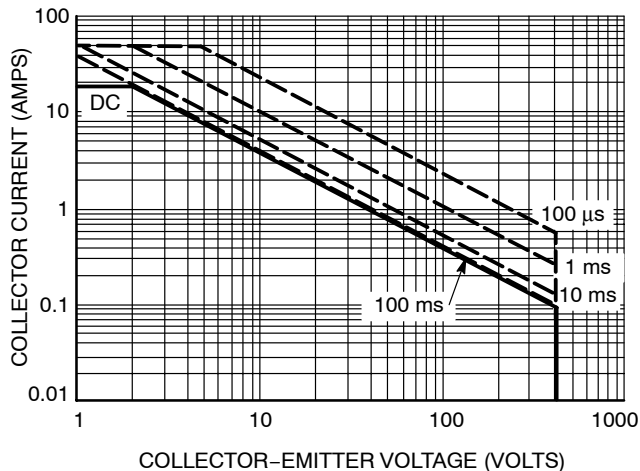

Figure 14. Single Pulse Safe Operating Area (Mounted on an Infinite Heatsink at $T_A = 125^\circ\text{C}$)

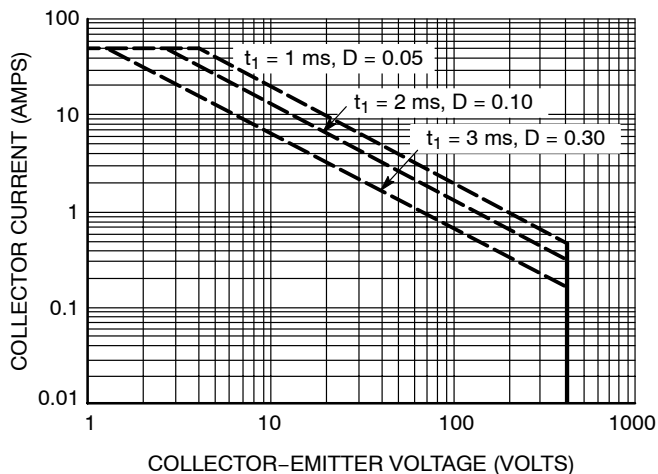

Figure 15. Pulse Train Safe Operating Area (Mounted on an Infinite Heatsink at $T_C = 25^\circ\text{C}$)

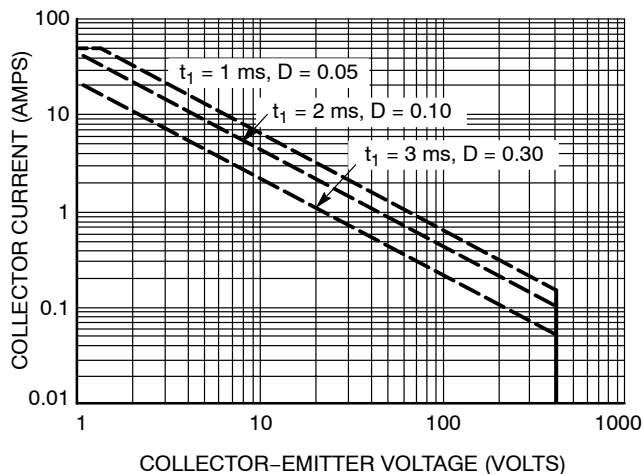

Figure 16. Pulse Train Safe Operating Area (Mounted on an Infinite Heatsink at $T_C = 125^\circ\text{C}$)

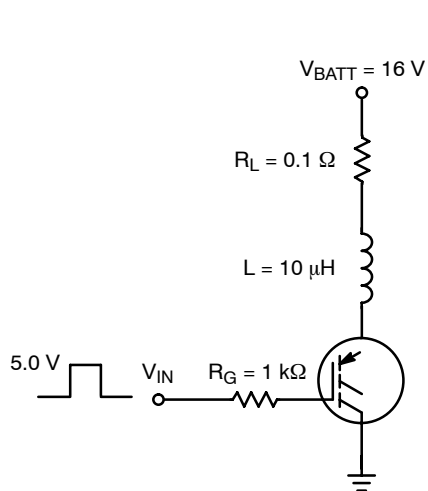

Figure 17. Circuit Configuration for Short Circuit Test #1

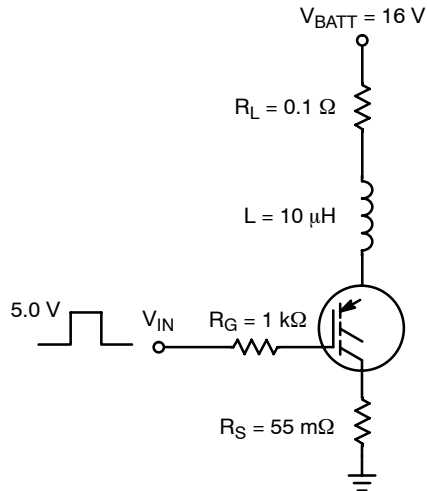
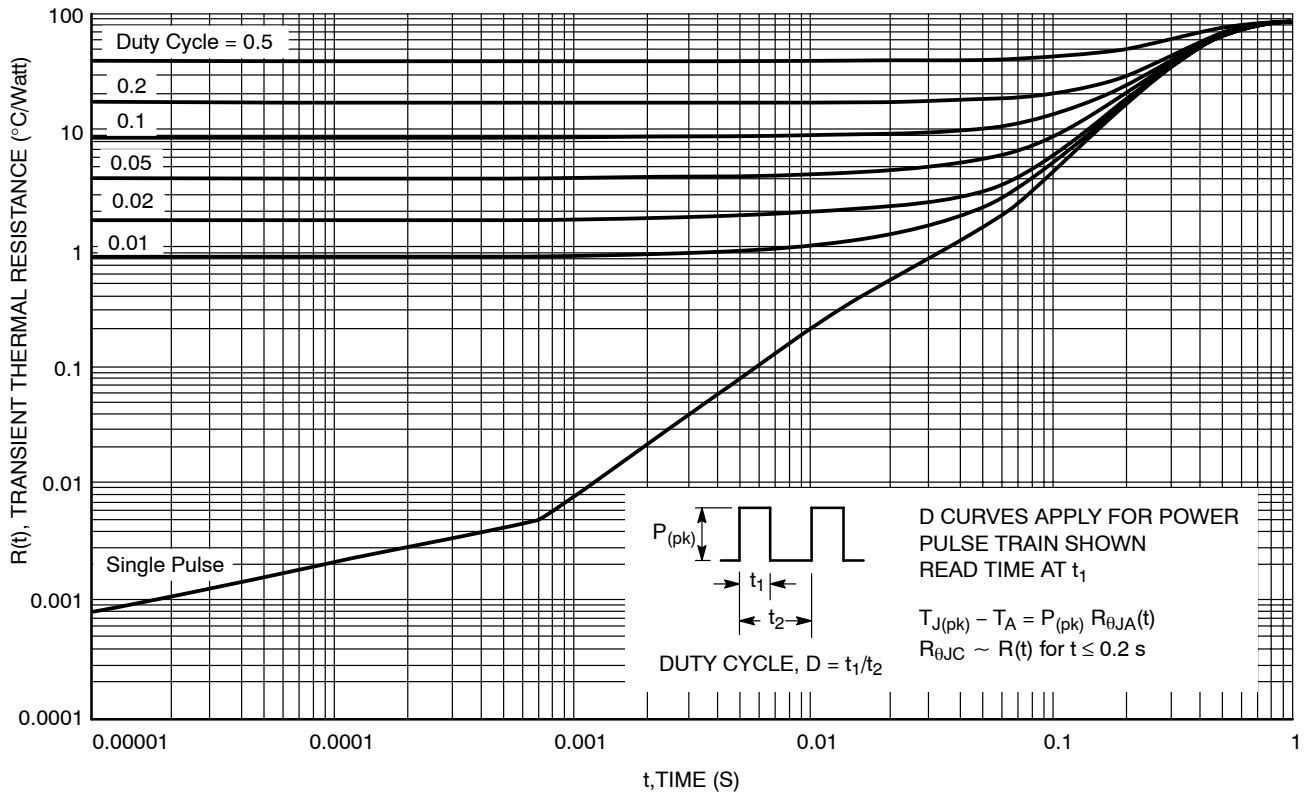

Figure 18. Circuit Configuration for Short Circuit Test #2

NGD18N40CLB

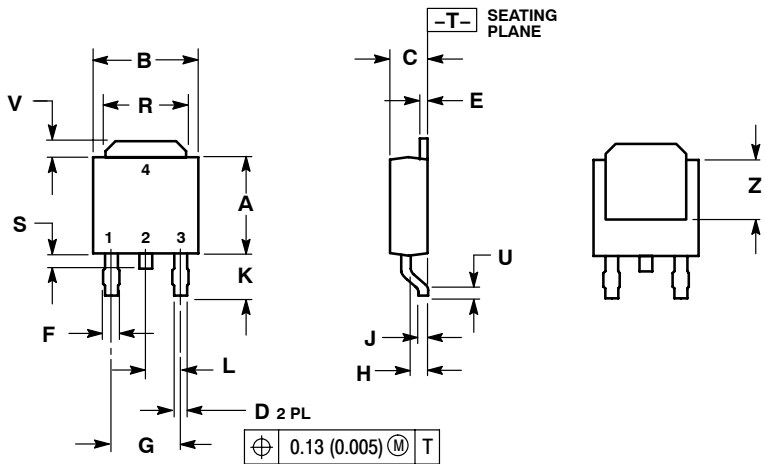

**Figure 19. Transient Thermal Resistance
(Non-normalized Junction-to-Ambient mounted on
minimum pad area)**

NGD18N40CLB

PACKAGE DIMENSIONS

DPAK
CASE 369C-01
ISSUE O



- NOTES:
1. DIMENSIONING AND TOLERANCING PER ANSI Y14.5M, 1982.
2. CONTROLLING DIMENSION: INCH.

DIM	INCHES		MILLIMETERS	
	MIN	MAX	MIN	MAX
A	0.235	0.245	5.97	6.22
B	0.250	0.265	6.35	6.73
C	0.086	0.094	2.19	2.38
D	0.027	0.035	0.69	0.88
E	0.018	0.023	0.46	0.58
F	0.037	0.045	0.94	1.14
G	0.180 BSC		4.58 BSC	
H	0.034	0.040	0.87	1.01
J	0.018	0.023	0.46	0.58
K	0.102	0.114	2.60	2.89
L	0.090 BSC		2.29 BSC	
R	0.180	0.215	4.57	5.45
S	0.025	0.040	0.63	1.01
U	0.020	---	0.51	---
V	0.035	0.050	0.89	1.27
Z	0.155	---	3.93	---

- STYLE 7:
PIN 1. GATE
2. COLLECTOR
3. EMITTER
4. COLLECTOR

ON Semiconductor and  are registered trademarks of Semiconductor Components Industries, LLC (SCILLC). SCILLC reserves the right to make changes without further notice to any products herein. SCILLC makes no warranty, representation or guarantee regarding the suitability of its products for any particular purpose, nor does SCILLC assume any liability arising out of the application or use of any product or circuit, and specifically disclaims any and all liability, including without limitation special, consequential or incidental damages. "Typical" parameters which may be provided in SCILLC data sheets and/or specifications can and do vary in different applications and actual performance may vary over time. All operating parameters, including "Typicals" must be validated for each customer application by customer's technical experts. SCILLC does not convey any license under its patent rights nor the rights of others. SCILLC products are not designed, intended, or authorized for use as components in systems intended for surgical implant into the body, or other applications intended to support or sustain life, or for any other application in which the failure of the SCILLC product could create a situation where personal injury or death may occur. Should Buyer purchase or use SCILLC products for any such unintended or unauthorized application, Buyer shall indemnify and hold SCILLC and its officers, employees, subsidiaries, affiliates, and distributors harmless against all claims, costs, damages, and expenses, and reasonable attorney fees arising out of, directly or indirectly, any claim of personal injury or death associated with such unintended or unauthorized use, even if such claim alleges that SCILLC was negligent regarding the design or manufacture of the part. SCILLC is an Equal Opportunity/Affirmative Action Employer. This literature is subject to all applicable copyright laws and is not for resale in any manner.

PUBLICATION ORDERING INFORMATION

LITERATURE FULFILLMENT:
Literature Distribution Center for ON Semiconductor
P.O. Box 5163, Denver, Colorado 80217 USA
Phone: 303-675-2175 or 800-344-3860 Toll Free USA/Canada
Fax: 303-675-2176 or 800-344-3867 Toll Free USA/Canada
Email: orderlit@onsemi.com

N. American Technical Support: 800-282-9855 Toll Free USA/Canada
Europe, Middle East and Africa Technical Support:
Phone: 421 33 790 2910
Japan Customer Focus Center
Phone: 81-3-5773-3850

ON Semiconductor Website: www.onsemi.com
Order Literature: <http://www.onsemi.com/orderlit>

For additional information, please contact your local Sales Representative